

DMX 512 CONTROLLER SERIES

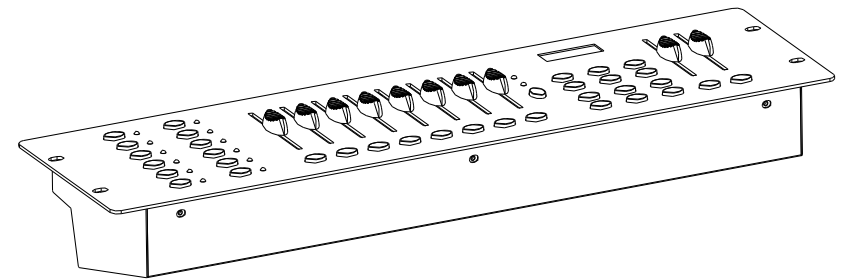

USER MANUAL

Version:1.0 14 Septem 2012

This product manual contains important information about the safe installation and use of this projector. Please read and follow these instructions carefully and keep this manual in a safe place for future reference.

Contents

- 1. Before you begin**
 - 1.1 What are included..... 2
 - 1.2 Unpacking instructions..... 2
 - 1.3 Safety instructions 2
- 2. Installation**
 - 2.1 Features 3
 - 2.2 General overview..... 3
 - 2.3 Product overview (front)..... 3
 - 2.4 Product overview (rear panel) 5
 - 2.5 Common terms..... 6
- 3. Operating instructions**
 - 3.1 SETUP**
 - 3.1.1 Setting up the System..... 6
 - 3.1.2 Fixture Addressing..... 7
 - 3.1.3 Pan and tilt channels 7
 - 3.1.4 Resetting the system 8
 - 3.1.5 Copy Scanner 8
 - 3.1.6 Fade Time Assign..... 8
 - 3.2 OPERATION**
 - 3.2.1 Manual Mode..... 9
 - 3.2.2 Review Scene or Chase..... 9
 - 3.3 PROGRAMMING**
 - 3.3.1 Entering program mode..... 9
 - 3.3.2 Create a scene..... 9
 - 3.3.3 Running a Program..... 10
 - 3.3.4 Check Program..... 10
 - 3.3.5 Editing a Program..... 10
 - 3.3.6 Copy a Program..... 10
 - 3.4 CHASE PROGRAMMING**
 - 3.4.1 Create a chase..... 11
 - 3.4.2 Running a Chase..... 11
 - 3.4.3 Checking a Chase..... 11
 - 3.4.4 Edit Chase (Copy Bank Into Chase)..... 11
 - 3.4.5 Edit Chase (Copy Scene Into Chase)..... 12
 - 3.4.6 Edit Chase (Insert Scene Into a Chase)..... 12
 - 3.4.7 Delete a scene in a Chase..... 12
 - 3.4.8 Delete a Chase..... 12
 - 3.4.9 Delete all Chase Programs..... 13
 - 3.5 SCENE PROGRAMMING (STEPS)**
 - 3.5.1 Insert a scene..... 13
 - 3.5.2 Copy a scene..... 13
 - 3.5.3 Delete a scene..... 14
 - 3.5.4 Delete all scenes..... 14
 - 3.6 PLAYBACK**
 - 3.6.1 Running in Sound-Mode..... 14
 - 3.6.2 Running in Auto-Mode..... 14
 - 3.6.3 Blackout..... 15
 - 3.7 MIDI OPERATION..... 15**
- 4 APPENDIX**
 - 4.1 DMX Primer..... 16
 - 4.2 Fixture Linking..... 16
 - 4.3 DMX dipswitch quick reference chart..... 17
 - 4.4 Technical specifications 18

4.4 Technical Specifications

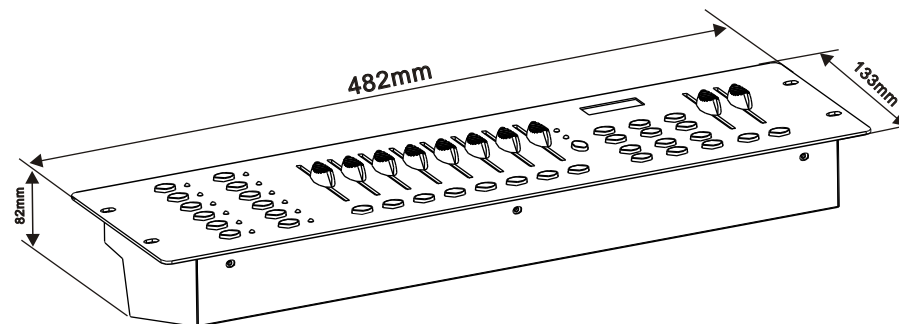

- Dimensions..... 482 X133 X82 mm
- Weight..... 2.0 Kg
- Operating Range.....DC 9V-12V 500mAmin
- Maximum ambient temperature.....45° C
- Data input locking 3-pin XLR male socket
- Data output locking 3-pin XLR female socket
- Data pin configurationpin 1 shield, pin 2 (-), pin 3 (+)
- Protocols.....DMX-512 USITT

4.3 DMX Dipswitch Quick Reference Chart

DMX Address Quick Reference Chart																				
Dip Switch Position																				
DMX DIP SWITCH SET 0=OFF 1=ON X=OFF or ON	#9	0	0	0	0	0	0	0	0	1	1	1	1	1	1	1				
	#8	0	0	0	0	1	1	1	1	0	0	0	0	1	1	1				
	#7	0	0	1	1	0	0	1	1	0	0	1	1	0	0	1				
	#6	0	1	0	1	0	1	0	1	0	1	0	1	0	1	0				
#1	#2	#3	#4	#5																
0	0	0	0	0	32	64	96	128	160	192	224	256	288	320	352	384	416	448	480	
1	0	0	0	0	1	33	65	97	129	161	193	225	257	289	321	353	385	417	449	481
0	1	0	0	0	2	34	66	98	130	162	194	226	258	290	322	354	386	418	450	482
1	1	0	0	0	3	35	67	99	131	163	195	227	259	291	323	355	387	419	451	483
0	0	1	0	0	4	36	68	100	132	164	196	228	260	292	324	356	388	420	452	484
1	0	1	0	0	5	37	69	101	133	165	197	229	261	293	325	357	389	421	453	485
0	1	1	0	0	6	38	70	102	134	166	198	230	262	294	326	358	390	422	454	486
1	1	1	0	0	7	39	71	103	135	167	199	231	263	295	327	359	391	423	455	487
0	0	0	1	0	8	40	72	104	136	168	200	232	264	296	328	360	392	424	456	488
1	0	0	1	0	9	41	73	105	137	169	201	233	265	297	329	361	393	425	457	489
0	1	0	1	0	10	42	74	106	138	170	202	234	266	298	330	362	394	426	458	490
1	1	0	1	0	11	43	75	107	139	171	203	235	267	299	331	363	395	427	459	491
0	0	1	1	0	12	44	76	108	140	172	204	236	268	300	332	364	396	428	460	492
1	0	1	1	0	13	45	77	109	141	173	205	237	269	301	333	365	397	429	461	493
0	1	1	1	0	14	46	78	110	142	174	206	238	270	302	334	366	398	430	462	494
1	1	1	1	0	15	47	79	111	143	175	207	239	271	303	335	367	399	431	463	495
0	0	0	0	1	16	48	80	112	144	176	208	240	272	304	336	368	400	432	464	496
1	0	0	0	1	17	49	81	113	145	177	209	241	273	305	337	369	401	433	465	497
0	1	0	0	1	18	50	82	114	146	178	210	242	274	306	338	370	402	434	466	498
1	1	0	0	1	19	51	83	115	147	179	211	243	275	307	339	371	403	435	467	499
0	0	1	0	1	20	52	84	116	148	180	212	244	276	308	340	372	404	436	468	500
1	0	1	0	1	21	53	85	117	149	181	213	245	277	309	341	373	405	437	469	501
0	1	1	0	1	22	54	86	118	150	182	214	246	278	310	342	374	406	438	470	502
1	1	1	0	1	23	55	87	119	151	183	215	247	279	311	343	375	407	439	471	503
0	0	0	1	1	24	56	88	120	152	184	216	248	280	312	344	376	408	440	472	504
1	0	0	1	1	25	57	89	121	153	185	217	249	281	313	345	377	409	441	473	505
0	1	0	1	1	26	58	90	122	154	186	218	250	282	314	346	378	410	442	474	506
1	1	0	1	1	27	59	91	123	155	187	219	251	283	315	347	379	411	443	475	507
0	0	1	1	1	28	60	92	124	156	188	220	252	284	316	348	380	412	444	476	508
1	0	1	1	1	29	61	93	125	157	189	221	253	285	317	349	381	413	445	477	509
0	1	1	1	1	30	62	94	126	158	190	222	254	286	318	350	382	414	446	478	510
1	1	1	1	1	31	63	95	127	159	191	223	255	287	319	351	383	415	447	479	511

Dip Switch Position

DMX Address

1.1 What are included

- 1) DMX-512 Controller
- 2) DC 9-12V 500mA, 90V~240V Power Adapter
- 3) Manual

1.2 Unpacking Instructions

Immediately upon receiving a fixture, carefully unpack the carton, check the contents to ensure that all parts are present, and have been received in good condition. Notify the shipper immediately and retain packing material for inspection if any parts appear damaged from shipping or the carton itself shows signs of mishandling. Save the carton and all packing materials. In the event that a fixture must be returned to the factory, it is important that the fixture be returned in the original factory box and packing.

1.3 Safety Instructions



Please read these instructions carefully, which includes important information about the installation, usage and maintenance .

- * Please keep this User Guide for future consultation. If you sell the unit to another user, be sure that they also receive this instruction booklet.
- * Always make sure that you are connecting to the proper voltage and that the line voltage you are connecting to is not higher than that stated on decal or rear panel of the fixture.
- * This product is intended for indoor use only!
- * To prevent risk of fire or shock, do not expose fixture to rain or moisture. Make sure there are no flammable materials close to the unit while operating.
- * The unit must be installed in a location with adequate ventilation, at least 50cm from adjacent surfaces. Be sure that no ventilation slots are blocked.
- * Always disconnect from power source before servicing or replacing lamp or fuse and be sure to replace with same lamp source.
- * In the event of serious operating problem, stop using the unit immediately. Never try to repair the unit by yourself. Repairs carried out by unskilled people can lead to damage or malfunction. Please contact the nearest authorized technical assistance center. Always use the same type spare parts.
- * Don't connect the device to a dimmer pack.
- * Make sure power cord is never crimped or damaged.
- * Never disconnect power cord by pulling or tugging on the cord.
- * Do not operate this device under 113° F ambient temperature conditions.

2. INTRODUCTION

2.1 Features

- * DMX512/1990 Standard
- * Controls 12 intelligent lights of up to 16 channels, totally 192 channels
- * 23 banks, each with 8 scenes; 6 chase, each with up to 184 scenes
- * Record up to 6 chases with fade time and speeds
- * MIDI control over banks, chases and blackout
- * Built-in microphone for music mode
- * Auto mode program controlled by fade time sliders
- * DMX in/out: 3 pin XRL
- * Plastic end housing
- * Auto-save last running program when switch off or power off and continue play last running program while switch ON or power ON again.

2.2 General Overview

- * The Controller is a universal intelligent lighting controller. It allows the control of 12 fixtures composed of 16 channels each and up to 184 programmable scenes. Six chase banks can contain up to 184 steps composed of the saved scenes and in any order. Programs can be triggered by music, midi, automatically or manually. All chases can be executed at the same time.
- * On the surface you will find various programming tools such as 8 universal channel sliders, quick access scanner and scene buttons, and an LED display indicator for easier navigation of controls and menu functions.

2.3 Product Overview (front)

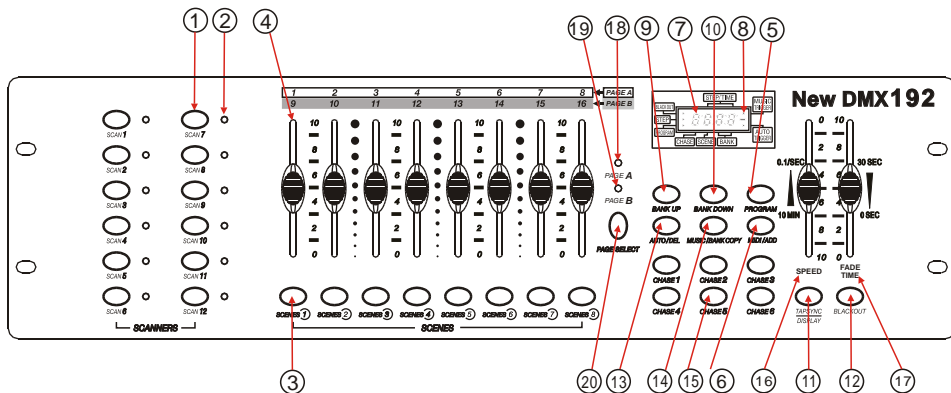

4 APPENDIX

4.1 DMX Primer

There are 512 channels in a DMX-512 connection. Channels may be assigned in any manner. A fixture capable of receiving DMX 512 will require one or a number of sequential channels. The user must assign a starting address on the fixture that indicates the first channel reserved in the controller. There are many different types of DMX controllable fixtures and they all may vary in the total number of channels required. Choosing a start address should be planned in advance. Channels should never overlap. If they do, this will result in erratic operation of the fixtures whose starting address is set incorrectly. You can however, control multiple fixtures of the same type using the same starting address as long as the intended result is that of unison movement or operation. In other words, the fixtures will be slaved together and all respond exactly the same.

DMX fixtures are designed to receive data through a serial Daisy Chain. A Daisy Chain connection is where the DATA OUT of one fixture connects to the DATA IN of the next fixture. The order in which the fixtures are connected is not important and has no effect on how a controller communicates to each fixture. Use an order that provides for the easiest and most direct cabling. Connect fixtures using shielded two conductor twisted pair cable with three pin XLR male to female connectors. The shield connection is pin 1, while pin 2 is Data Negative (S-) and pin 3 is Data positive (S+).

4.2 FIXTURE LINKING

Occupation of the XLR-connection:

DMX-OUTPUT
XLR mounting-socket:

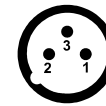

- 1- Ground
- 2 - Signal (-)
- 3 - Signal (+)

DMX-OUTPUT
XLR mounting-plug:

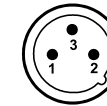

- 1- Ground
- 2 - Signal (-)
- 3 - Signal (+)

Caution: At the last fixture, the DMX-cable has to be terminated with a terminator. Solder a 120Ω resistor between Signal (-) and Signal (+) into a 3-pin XLR-plug and plug it in the DMX-output of the last fixture.

In the Controller mode, at the last fixture in the chain, the DMX output has to be connected with a DMX terminator. This prevents electrical noise from disturbing and corrupting the DMX control signals. The DMX terminator is simply an XLR connector with a 120W (ohm) resistor connected across pins 2 and 3, which is then plugged into the output socket on the last projector in the chain. The connections are illustrated below.

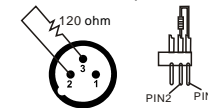

If you wish to connect DMX-controllers with other XLR-outputs, you need to use adapter-cables.

The transform of the controller line of 3 pins and 5 pins (plug and socket)

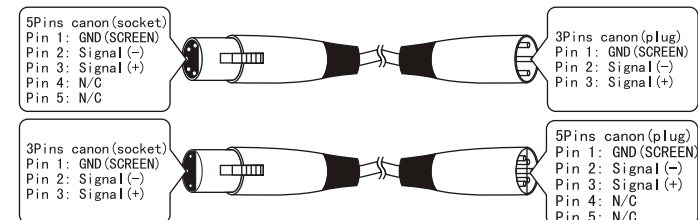

3.6.3 BLACKOUT

The **Blackout** button brings all lighting output to 0 or off.

3.7 Midi Operation

The controller will only respond to **MIDI** commands on the **MIDI** channel which it is set to full stop. All **MIDI** control is performed using Note on commands. All other **MIDI** instructions are ignored. To stop a chase, send the blackout on note.

Action :

- 1) Press and hold the **MIDI/ADD** button for about 3 seconds.
- 2) Select the MIDI control channel (1-16) via the **BANK UP/DOWN** buttons to set.
- 3) Press and hold the **MIDI/ADD** button for 3 seconds to save settings.
- 4) To release **MIDI** control, press any other button except the **BANK** buttons during step 2.

Notes :

This is the Channel that the controller will receive MIDI note commands.

MIDI NOTE	FUNCTION (TURN ON/OFF)
00 to 07	Scenes 1-8 in BANK 1
08 to 15	Scenes 1-8 in BANK 2
16 to 23	Scenes 1-8 in BANK 3
24 to 31	Scenes 1-8 in BANK 4
32 to 39	Scenes 1-8 in BANK 5
40 to 47	Scenes 1-8 in BANK 6
48 to 55	Scenes 1-8 in BANK 7
56 to 63	Scenes 1-8 in BANK 8
64 to 71	Scenes 1-8 in BANK 9
72 to 79	Scenes 1-8 in BANK 10
80 to 87	Scenes 1-8 in BANK 11

MIDI NOTE	FUNCTION (TURN ON/OFF)
88 to 95	Scenes 1-8 in BANK 12
96 to 103	Scenes 1-8 in BANK 13
104 to 111	Scenes 1-8 in BANK 14
112 to 119	Scenes 1-8 in BANK 15
120	Chase 1
121	Chase 2
122	Chase 3
123	Chase 4
124	Chase 5
125	Chase 6
126	BLACKOUT

Item	Button or Fader	Function
1	Scanner select buttons	Fixture selection
2	Scanner indicator LEDS	Indicates the fixtures currently selected
3	Scene select buttons	Universal bump buttons representing scene location for storage and selection
4	Channel faders	For adjusting DMX values, Ch 1-8 can be adjusted immediately after pressing the respective scanner select button, Ch 9-16 after pressing the Page select button
5	Program button	Used to enter programming mode
6	Music/Bank Copy button	Used to activate Music mode and as the copy command during programming
7	LED display window	Status window displays pertinent operational data
8	Mode Indicator LEDS	Provides operating mode status, (manual, music or auto)
9	Bank Up button	Function button to traverse Scene/Steps in banks or chases
10	Bank Down button	Function button to traverse Scene/Steps in banks or chases
11	Tap Display button	Sets the chase speed by tapping, and toggles between values and percentages.
12	Blackout button	Sets the shutter or dimmer value of all fixtures to "0" causing all light output to cease
13	Midi/ADD button	Activates MIDI external control and also used to confirm the record/save process
14	Auto/Del button	Used to activate Auto mode and as the delete function key during programming
15	Chaser buttons	Chase memory 1 - 6
16	Speed fader	This will adjust the hold time of a scene or a step within a chase
17	Fade-Time fader	Also considered a cross-fade, sets the interval time between two scenes in a chase
18	Page A Indicator LED	Represents Ch 1-8 range selected,
19	Page B Indicator LED	Represents Ch 9-16 range selected
20	Page select button	In manual mode, press to toggle between pages of control.

2.4 Product Overview (rear panel)

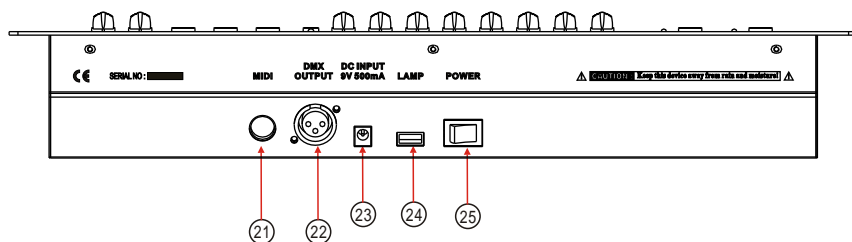

Item	Button or Fader	Function
21	MIDI input port	For external triggering of Banks and Chases using a MIDI device
22	DMX output connector	DMX control signal
23	DC Input jack	Main power feed
24	USB Lamp socket	
25	ON/OFF power switch	Turns the controller on and off

3.5.3 DELETE A SCENE

Action :

- 1) Press and hold the **PROGRAM** button to enter programming mode.
- 2) Select the **BANK** that contains the scene to be deleted by using the **BANK UP/DOWN** buttons.
- 3) Press and hold the **AUTO DEL** button.
- 4) Press the **SCENE** button that corresponds to the scene you want to delete. All LEDs will blink.

Notes :

When deleting a scene the physical location is not removed, however, all 192 DMX channels available to the scene will be set to value 0.

3.5.4 DELETE ALL SCENES

Action :

- 1) Press and hold the **PROGRAM** button and the **BANK DOWN** button while turning off power to the controller.
- 2) Turn the controller back on.

Notes :

CAUTION!
This process is irreversible. All scenes with data will be set to 0.

3.6 Playback

3.6.1 RUNNING IN SOUND-MODE

Action :

- 1) Press the **MUSIC BANK COPY** button until the **MUSIC LED** turns on.
- 2) Select the program **BANK** to run in sound active mode using the **BANK UP/DOWN** buttons.
- 3) Alternatively you can press a single **CHASE** button (1-6) or several **CHASE** buttons in sequence and all selected chases will loop in the order selected.
- 4) You can adjust the duration time using the **FADE TIME** fader.

Notes :

In the Sound mode, programs will be triggered by the sound using its built-in microphone.

Multiple chases selected will loop and run in the order originally selected.

3.6.2 RUNNING IN AUTO-MODE

Action :

- 1) Press the **AUTO DEL** button until the **AUTO LED** turns on.
- 2) If a **CHASE** button is not pressed the controller will automatically run a **BANK** program.
- 3) Change **BANK** programs by using **BANK UP/DOWN** buttons.
- 4) Alternatively you can press a single **CHASE** button (1-6) or several **CHASE** buttons in sequence and all selected chases will loop in the order selected.
- 5) You can adjust the time between steps by moving the **SPEED** fader and the duration of the step by moving the **FADE TIME** fader.

Notes :

In the Auto mode, programs will be triggered by controllers fade and speed time as set on the faders.

Multiple chases selected will loop and run in the order originally selected.

3.4.9 DELETE ALL CHASE PROGRAMS

CAUTION! This procedure will result in irrevocable loss of chase step memory. The individual scenes and program banks will be preserved.

Action :

- 1) Turn OFF controller.
- 2) Press and hold the **BANK DOWN** button and the **AUTO DEL** button while turning ON the controller.
- 3) All LEDs will blink.

Notes :

3.5 Scene Programming (Steps)

3.5.1 INSERT A SCENE

Action :

- 1) Press and hold the **PROGRAM** button to enter programming mode.
- 2) Press the desired **CHASE** button.
- 3) Press the **TAPSYNC DISPLAY** to switch the LED display to steps view.
- 4) Use the **BANK UP/DOWN** buttons to navigate steps and locate the insert point of the new scene. The display will read the step number.
- 5) Press **MIDI/ADD** button to prepare the insert.
- 6) Use the **BANK UP/DOWN** button to locate the **SCENE**.
- 7) Press the **SCENE** button that corresponds to the scene to be inserted.
- 8) Press **MIDI/ADD** button to insert the scene. All LEDs will blink.

Notes :

/e. To insert a scene between Steps 05 and 06 navigate using BANK buttons until the display reads STEP05.

3.5.2 COPY A SCENE

Action :

- 1) Press and hold the **PROGRAM** button to enter programming mode.
- 2) Select the **BANK** that contains the scene to be copied using the **BANK UP/DOWN** buttons.
- 3) Press the **SCENE** button that corresponds to the scene to be copied.
- 4) Press **MIDI/ADD** button to copy the scene.
- 5) Select the destination **BANK** that contains the scene memory to record onto using the **BANK UP/DOWN** buttons.
- 6) Press the desired **SCENE** button to complete copy. All LEDs will blink.

Notes :

2.5 Common Terms

The following are common terms used in intelligent light programming.

Blackout is a state by where all lighting fixtures light output are set to 0 or off, usually on a temporary basis.

DMX-512 is an industry standard digital communication protocol used in entertainment lighting equipment. For more information read Sections “DMX Primer” and “DMX Control Mode” in the Appendix.

Fixture refers to your lighting instrument or other device such as a fogger or dimmer of which you can control.

Programs are a bunch of scenes stacked one after another. It can be programmed as either a single scene or multiple scenes in sequence.

Scenes are static lighting states.

Sliders also known as faders.

Chases can also be called programs. A chase consists of a bunch of scenes stacked one after another.

Scanner refers to a lighting instrument with a pan and tilt mirror; however, in the ILS-CON controller it can be used to control any DMX-512 compatible device as a generic fixture.

MIDI is a standard for representing musical information in a digital format. A MIDI input would provide external triggering of scenes using midi device such as a midi keyboard.

Stand Alone refers to a fixture's ability to function independently of an external controller and usually in sync to music, due to a built in microphone.

Fade slider is used to adjust the time between scenes within a chase.

Speed slider affects the amount of time a scene will hold its state. It is also considered a wait time.

Shutter is a mechanical device in the lighting fixture that allows you to block the lights path. It is often used to lessen the intensity of the light output and to strobe.

Patching refers to the process of assigning fixtures a DMX channel or.

Playbacks can be either scenes or chases that are directly called to execution by the user. A playback can also be considered program memory that can be recalled during a show.

3. OPERATING INSTRUCTIONS

3.1 Setup

3.1.1 SETTING UP THE SYSTEM

- 1) Plug the AC to DC power supply to the system back panel and to the mains outlet.
- 2) Plug in your DMX cable(s) to your intelligent lighting as described in the fixtures respective manual. For a quick Primer on DMX see the “DMX Primer” section in the Appendix of this manual.

3.1.2 FIXTURE ADDRESSING

The Controller is programmed to control 16 channels of DMX per fixture therefore the fixtures you wish to control with the corresponding “**SCANNER**” buttons on the unit, must be spaced 16 channels apart.

FIXTURE OR SCANNER #	DEFAULT DMX STARTING ADDRESS	BINARY DIPSWITCH SETTINGS SWITCH TO THE “ ON POSITION”
1	1	1
2	17	1 , 5
3	33	1 , 6
4	49	1 , 5 , 6
5	65	1 , 7
6	81	1 , 5 , 7
7	97	1 , 6 , 7
8	113	1 , 5 , 6 , 7
9	129	1 , 8
10	145	1 , 5 , 8
11	161	1 , 6 , 8
12	177	1 , 5 , 6 , 8

Please refer to your individual fixture’s manual for DMX addressing instructions. The table above refers to a standard 9 dipswitch binary configurable device.

3.1.3 PAN AND TILT CHANNELS

Because not all intelligent lighting fixtures are alike or share the same control attributes, the Controller allows the user to assign the wheel the correct pan and tilt channel for every individual fixture

Action :

- 1) Press and hold **PROGRAM & TAPSYNC** different DMX channel. Faders are given a channel buttons together (1) time to access the number and are labeled on the surface of the channel assignment mode.
- 2) Press a **SCANNER** button that represents the fixture whose faders you would like to re-assign.

Notes :

All pan/tilt can be re-assigned to output on a different DMX channel. Press **AUTO/DEL** buttons to delete the channel assignment mode.

3.4.5 EDIT CHASE (COPY SCENE INTO CHASE)

Action :

- 1) Press and hold the **PROGRAM** button to enter programming mode.
- 2) Press the desired **CHASE** button.
- 3) Select the **BANK** that contains the scene to be copied using the **BANK UP/DOWN** buttons.
- 4) Press the **SCENE** button that corresponds to the scene to be copied.
- 5) Press **MIDI/ADD** button to copy the scene. All LEDs will blink.

Notes :

3.4.6 EDIT CHASE (INSERT SCENE INTO A CHASE)

Action :

- 1) Press and hold the **PROGRAM** button to enter programming mode.
- 2) Press the desired **CHASE** button.
- 3) Press the **TAPSYNC DISPLAY** to switch the LED display to steps view.
- 4) Use the **BANK UP/DOWN** buttons to navigate steps and locate the insert point of the new scene. The display will read the step number.
- 5) Press **MIDI/ADD** button to prepare the insert.
- 6) Use the **BANK UP/DOWN** button to locate the **SCENE**.
- 7) Press the **SCENE** button that corresponds to the scene to be inserted.
- 8) Press **MIDI/ADD** button to insert the scene. All LEDs will blink.

Notes :

/i.e. To insert a scene between Steps 05 and 06 navigate using **BANK** buttons until the display reads STEP05.

3.4.7 DELETE A SCENE IN A CHASE

Action :

- 1) Press and hold the **PROGRAM** button to enter programming mode.
- 2) Press the desired **CHASE** button that contains the scene to be deleted.
- 3) Press the **TAPSYNC DISPLAY** button to switch the LED display to steps.
- 4) Select the scene/step to be deleted using the **BANK UP/DOWN** buttons.
- 5) Press **AUTO DEL** button to delete the step/scene. All LEDs will blink.

Notes :

3.4.8 DELETE A CHASE

Action :

- 1) Press and hold the **PROGRAM** button to enter programming mode.
- 2) Press the **CHASE** button (1-6) to be deleted.
- 3) Press and hold **AUTO DEL** button and the respective **CHASE** button to delete the chase. All LEDs will blink.

Notes :

3.4 Chase Programming

A chase is created by using previously created scenes. Scenes become steps in a chase and can be arranged in any order you choose. It is highly recommended that prior to programming chases for the first time; you delete all chases from memory. See "Delete All Chases" for instructions.

3.4.1 CREATE A CHASE

A Chase can contain 184 scenes as steps. The term steps and scenes are used interchangeably.

Action :

- 1) Press the **PROGRAM** button until the LED blinks.
- 2) Press the **CHASE** (1~6) button you wish to program.
- 3) Change **BANK** if necessary to locate a scene.
- 4) Select the **SCENE** to insert.
- 5) Tap the **MIDI/ADD** button to store.
- 6) Repeat steps 3 ~ 5 to add additional steps in the chase. Up to 184 steps can be recorded.
- 7) Press and hold the **PROGRAM** button to save the chase.

Notes :

3.4.2 RUNNING A CHASE

Action :

- 1) Press a **CHASE** button then press the **AUTO DEL** button.
- 2) Adjust the Chase speed by tapping the **TAPSYNC DISPLAY** button twice at a rate of your choosing.

Notes :

The time between 2 taps will set the chase speed (up to 10 minutes)

3.4.3 CHECKING A CHASE

Action :

- 1) Press and hold the **PROGRAM** button until the LED is light.
- 2) Select the desired **CHASE** button.
- 3) Press the **TAPSYNC DISPLAY** button to switch the LED display to steps.
- 4) Review each scene/step individually by using the **BANK UP/DOWN** buttons.

Notes :

3.4.4 EDIT CHASE (COPY BANK INTO CHASE)

Action :

- 1) Press and hold the **PROGRAM** button to enter programming mode.
- 2) Press the desired **CHASE** button.
- 3) Select the **BANK** to be copied using the **BANK UP/DOWN** buttons.
- 4) Press **MUSIC/BANK COPY** button to prepare copy.
- 5) Press **MIDI/ADD** button to copy the bank. All LEDs will blink.

Notes :

- 3) Move one fader of 1-8 channel to select the pan channel. (press page button to toggle between pages)
- 4) Press the **TAPSYNC DISPLAY** button to select pan/ tilt
- 5) Move one fader of 1-8 channel to select the tilt channel.(press page button to toggle between pages)
- 6) press and hold **PROGRAM & TAPSYNC DISPLAY** buttons to exit and save setting. All LEDs will blink.

Notes :

All pan/tilt can be reassigned to output on a different DMX channel.

3.1.4 RESETTING THE SYSTEM

Warning:

this will reset the controller to its factory defaults. This will erase all programs and settings.

Action :

- 1) Turn off the unit.
- 2) Press and hold **BANK UP** and **AUTO/DEL**.
- 3) Turn on power to the unit (while still holding **BANK UP** and **AUTO/DEL**).

Notes :

3.1.5 COPY SCANNER

Example: Copying Scanner 1 into Scanner 2

Action :

- 1) Press and hold **SCANNER** button # 1.
- 2) While holding button # 1 press **SCANNER** button # 2.
- 3) Release **SCANNER** button # 1 first before releasing **SCANNER** button # 2.
- 4) All **SCANNER** LED indicators will flash to confirm successful copy.

Notes :

To save time, you can copy the settings of one Scanner button to another.

3.1.6 FADE TIME ASSIGN

You can choose whether the board's fade time during scene execution is implemented broadly to all output channels or only to the Pan & Tilt movement channels. This is relevant because often you will want gobos and colors to change quickly while not affecting the movement of the light.

Action :

- 1) Turn OFF the controller.
- 2) Hold the **BLACKOUT** and **TAPSYNC DISPLAY** buttons simultaneously.
- 3) Turn ON the controller.
- 4) Press the **TAPSYNC DISPLAY** button to toggle between the two modes. Either all channels (A) or select channel Pan & Tilt only (P)
- 5) Press **BLACKOUT** and **TAPSYNC DISPLAY** to save settings. All LEDs will blink to confirm.

Notes :

A: All channels P: Only Pan & Tilt

3.2 Operation

3.2.1 MANUAL MODE

The manual mode allows direct control of all scanners. You are able to move them and change attributes by using the channel faders.

Action :

- 1) Press the **AUTO DEL** button repeatedly until the **MANUAL LED** is lit.
- 2) Select a **SCANNER** button.
- 3) Move faders to change fixture attributes.
TAPSYNC DISPLAY button:
Press to toggle the output indicator on the LED display between DMX values (0-255) and percentage (0-100)

Notes :

All changes made while in Manual Mode are temporary and will not be recorded.

3.2.2 REVIEW SCENE OR CHASE

This instruction assumes that you have already recorded scenes and chases on the controller. Otherwise skip section and go to programming.

Action : (SCENE Review)

- 1) Select any one of the 23 banks by pressing the **BANK UP/DOWN** buttons.
- 2) Select a **SCENE** button (1-8) to review.
- 3) Move wheel and faders to change fixture attributes.

Action : (CHASE Review)

- 1) Press any one of the 6 **CHASE** buttons.
- 2) Press the **TAP DISPLAY** button to view the step number on the display.
- 3) Press the **BANK UP/DOWN** buttons review all scenes in the chase.

Notes :

Make sure you are still in MANUAL Mode.

3.3 Programming

A program (bank) is a sequence of different scenes (or steps) that will be called up one after another. In the controller 23 programs can be created of 8 scenes in each.

3.3.1 ENTERING PROGRAM MODE

- 1) Press the **Program** button until the LED blinks.

3.3.2 CREATE A SCENE :

A scene is a static lighting state. Scenes are stored in banks. There are 23 bank memories on the controller and each bank can hold 8 scene memories. The controller can save 184 scenes total.

Action :

- 1) Press the **PROGRAM** button until the LED blinks.
- 2) you can position **FADE** and **SPEED** to any place you need to achieve the effect you want to create.
- 3) Select the **SCANNERS** you wish to include in your scene.
- 4) Compose a look by moving the *sliders* and wheel.
- 5) Tap **MIDI/ADD** button.
- 6) Choose a **BANK** (01-23) to change if necessary.
- 7) Select a **SCENES** button to store.
- 8) Repeat steps 3 through 7 as necessary. 8 scenes can be recorded in a Program.

Notes :

Deselect Blackout if LED is lit.

You can select more than one fixture.

There are 8 scenes available in every bank.

All LEDs will flash to confirm. The LED display will now indicate the Scene number and Bank number used.

3.3.3 RUNNING A PROGRAM

Action :

- 1) Use **BANK UP/DOWN** buttons to change *Program* banks if necessary.
- 2) Press the **AUTO DEL** button repeatedly until the **AUTO LED** turns on.
- 3) Adjust the **PROGRAM** speed via the **SPEED** fader and the loop rate via the **FADE TIME** fader.
- 4) Alternatively you can tap the **TAPSYNC DISPLAY** button twice. The time between two taps sets the time between **SCENES** (up to 10 minutes).

Notes :

Deselect Blackout if LED is lit.

Also called a Tap-Sync.

3.3.4 CHECK PROGRAM

Action :

- 1) Press and hold the **PROGRAM** button until the LED blinks.
- 2) Use the **BANK UP/DOWN** buttons to select the **PROGRAM** bank to review.
- 3) Press the **SCENES** buttons to review each scene individually.

Notes :

3.3.5 EDITING A PROGRAM

Scenes will need to be modified manually.

Action :

- 1) Press and hold the **PROGRAM** button until the LED blinks.
- 2) Use **BANK UP/DOWN** buttons to change *Program* banks if necessary.
- 3) Select the desired fixture via the **SCANNERS** button.
- 4) Adjust and change fixture attributes using the channel faders and wheel.
- 5) Press the **MIDI/ADD** button to prepare the save.
- 6) Select the desired **SCENES** button to save.

Notes :

Deselect Blackout if LED is lit.

3.3.6 COPY A PROGRAM

Action :

- 1) Press and hold the **PROGRAM** button until the LED blinks.
- 2) Use **BANK UP/DOWN** buttons to select the **PROGRAM** bank you will copy.
- 3) Press the **MIDI/ADD** button to prepare the copy.
- 4) Use **BANK UP/DOWN** buttons to select the destination **PROGRAM** bank.
- 5) Press the **MUSIC BANK COPY** button to execute the copy. All LEDs on the controller will blink.

Notes :

All 8 scenes in a Program bank will be copied.